



AUTOCLIMA
QUALITY & COMFORT

GRUPPO MOTOCOMPRESSORE

MODULA MC

FICHE TECHNIQUE 3: GROUPE MOTO-COMPRESSEUR
DATA SHEET 3: MOTOR-COMPRESSOR UNIT



1



2



3



SCHEDA 3: GRUPPO MOTOCOMPRESSORE

 Il progetto "**MODULA**" è stato sviluppato per soddisfare le esigenze di chi non può o non vuole utilizzare un compressore trascinato dal motore termico del veicolo. È sufficiente avere a disposizione un'alimentazione elettrica a 12V / 24V oppure un'alimentazione di tipo idraulico. È modulare poiché è possibile scegliere fra più combinazioni: gruppo completo, gruppo motocondensante o gruppo motocompressore; di conseguenza il posizionamento dei componenti è il più svariato e flessibile anche grazie alla possibilità di abbinare evaporatori e/o condensatori differenti. Ecco quindi che il campo di applicazione è vasto: veicoli speciali di vario genere, elettrici, ibridi, agricoli, movimento terra, gru, cabine, ...

Gruppo motocompressore

Il gruppo motocompressore è la scelta di chi richiede il massimo della flessibilità.

Il gruppo racchiude in sé il compressore più un motore elettrico.

Lo si può collocare nella posizione più favorevole all'applicazione specifica e si può abbinare ad un evaporatore e ad un condensatore a scelta fra quelli consigliati in base alle esigenze.

 Le projet "**MODULA**" se développe pour satisfaire les exigences de ceux qui ne peuvent ou ne veulent pas utiliser un compresseur entraîné par le moteur thermique du véhicule. Il suffit donc d'avoir à disposition une alimentation électrique à 12V / 24V ou bien une alimentation de type hydraulique. Il est modulable car il est possible choisir parmi plusieurs combinaisons: groupe complet, groupe moto-condenseur ou groupe moto-compresseur; par conséquent, le positionnement des composants est très varié et flexible, ceci dû aussi au choix de évaporateurs et/ou condensateurs différents. Le domaine d'application est vaste: véhicules spéciaux de tous type, électriques, hybrides, agricoles, tout terrain, grues, cabines, ...

Groupe moto-compresseur

Le groupe moto-compresseur est celle qui offre le maximum de flexibilité.

Le groupe incorpore le compresseur et le moteur électrique.

On peut le placer dans l'emplacement plus favorable pour son application et le combiner avec évaporateur et condensateur, à choisir parmi la vaste gamme disponible, en fonction des besoins.

 The project "**MODULA**" has been developed to meet the needs of those unable or unwilling to use a compressor driven by thermal engine of the vehicle. It is sufficient to have available an electric power supply 12V / 24V or a power supply of hydraulic type. It is modular because you can choose between several combinations: complete unit, motor-condensing unit or motor-compressor unit and therefore the positioning of the components is the most diverse and flexible thanks the possibility to match evaporators and/or different condensers. Hence the scope range is vast: various types of special vehicles, electric, hybrid, agricultural, earthmoving, cranes, cabins, ...

Motor-compressor unit

The motor-compressor unit is the solution offering the maximum flexibility.

The unit embodies the compressor and the electric engine.

It can be placed in the best position for the specific application, and it can be matched with evaporator and condenser, to be chosen among the wide range available, depending from individual needs.

GRUPPO MOTOCOMPRESSORE MODULA MC elettrico

12V cod. 40471018

GRUPPO MOTOCOMPRESSORE MODULA MC elettrico

24V cod. 40471019

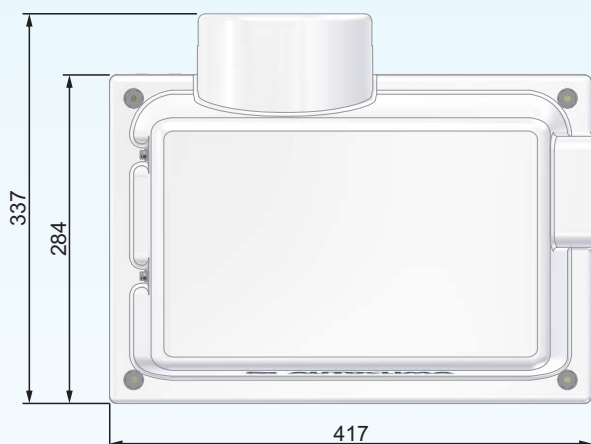
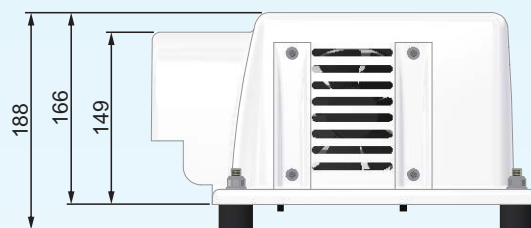
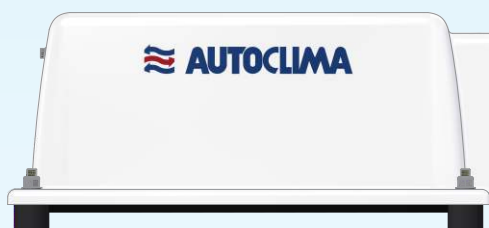

Esempio di possibili combinazioni / Exemple de combinaisons possibles / Example of possible combinations

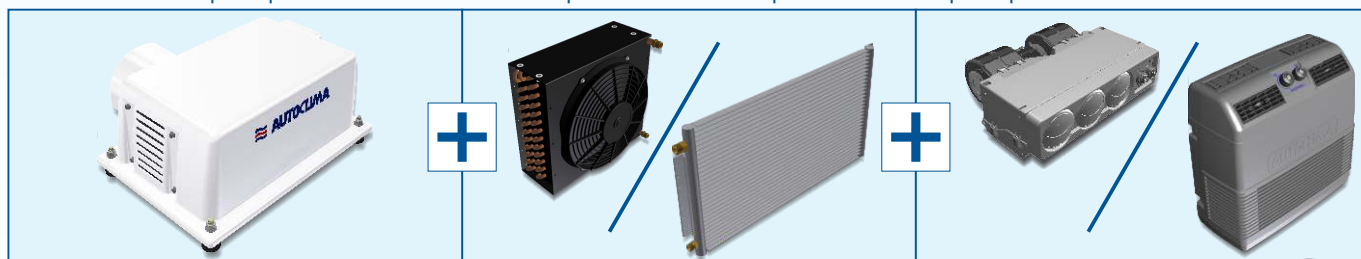

Dati tecnici nominali	Données techniques nominales	Nominal technical data	MODULA MC
<ul style="list-style-type: none"> • Potenza frigorifera evaporatore abbinabile • Alimentazione • Assorbimento elettrico • Refrigerante • Peso 	<ul style="list-style-type: none"> • Puissance frigorif. evaporat. correspondant • Alimentation • Absorption électrique • Réfrigérant • Poids 	<ul style="list-style-type: none"> • Cooling capacity of matching evaporator • Power supply • Power consumption • Coolant • Weight 	<p>Max 4 kW Elettrica - Eléctrique - Electrical: (12 VDC) / (24 VDC) (60 A@12VDC) / (30 A@24VDC) R134a 20 kg</p>

La nostra società si riserva il diritto di migliorare e modificare ciascuno dei modelli illustrati, senza alcun preavviso.

Notre Société se réserve le droit d'améliorer et de modifier sans aucun préavis chacun des modèles ci-illustrés.

The company reserves the right to modify any design in the model without prior notice as per our policy of continuous improvement of design, quality and performance.

Unsere Firma behält sich das Recht vor, jeden Modell hier erläutert ohne Vorankündigung zu ändern und verbessern.

La compañía se reserva el derecho a modificar cualquier diseño en los modelos sin previo aviso debido a la política de continua mejora en el diseño, en la calidad y en el rendimiento



Autoclima S.p.A. - 10020 Cambiano (TO) - ITALY
 Via Cavalieri di Vittorio Veneto, 15 - Tel. 011.94.43.210 - Fax 011.94.43.230
 Internet: <http://www.autoclima.com> e-mail: sales@autoclima.com

STAMPATO IN ITALIA - RIPRODUZIONE VIETATA

Cod. 80819219.1